

Uninterruptible power supply

COVER CORE

6-10 kVA

User manual



THE POWER IS ON

The content of this document is the copyright of the publisher and it may not be reproduced without permission. We reserve the right to modify the design and specifications without prior notice.

©Copyright 2016
COMEX S.A.
All rights reserved.

Table of contents

1.	Safety rules.....	1
2.	Transport, unpacking UPS.....	3
2.1.	Rack 19'' Installation	3
2.2.	Tower Installation	3
3.	Design and connection.....	4
3.1.	Rear panel view	4
3.2.	Connection of external batteries	5
3.3.	Connection of input and output.....	6
3.4.	Remote EPO connection	6
3.5.	Communications connection	7
4.	Operations of LCD	8
4.1.	Button operations	8
4.2.	LED indicators.....	9
4.3.	LCD Screen.....	10
4.4.	Signal alarms.....	11
4.5.	Letter abbreviations LCD	11
4.6.	Settings.....	12
4.7.	Description of UPS modes.....	15
4.8.	Warning codes.....	16
4.9.	Error codes	16
4.10.	Warnings UPS and audible alarms	17
4	Operation of UPS	18
5.1	Turn on UPS.....	18
5.2	Turn off UPS.....	18
5.3	Turn on UPS from batteries.....	18
5.5	Switch UPS from bypass service mode to normal mode	19
5.6	Battery test.....	19
5.7	Mute audible alarm	19
5.8	Software installation	19
6	Operating environment and operation of the UPS.....	20
6.1	Operating conditions.....	20
6.3	Battery replacement	20

1. Safety rules

This manual contains information on the safe use of the UPS. Before unpacking and installing the power supply, please read it carefully and follow its recommendations.

	Meets the standards - EXECUTION
EN 62040-3	Uninterruptible power systems (UPS): The methods for determining the properties and test requirements.

	Meets the standards - Electromagnetic compatibility
EN 62040-2 :2006 C2	Uninterruptible Power Supply (UPS): Electromagnetic compatibility.
EN 61000-2-2 :2002	Electromagnetic compatibility (EMC): Environment. Compatibility levels for disturbances Conducted LF and signaling in public low-voltage power systems.
EN 61000-4-2 :2009	Electromagnetic compatibility (EMC): Testing and measurement - test of resistance to electrostatic discharge.
EN 61000-4-3 :2006 +A2 :2010	Electromagnetic compatibility (EMC): Testing and measurement techniques - Test of resistance to electromagnetic field of radio frequency.
EN 61000-4-4 :2012	Electromagnetic compatibility (EMC): Testing and measurement techniques - Test of resistance to fast transients.
EN 61000-4-5 :2014	Electromagnetic compatibility (EMC): Testing and measurement techniques - Surge immunity test.
EN 61000-4-6 :2014	Electromagnetic compatibility (EMC): Testing and measurement techniques - Immunity to conducted disturbances, induced by radio-frequency fields.
EN 61000-4-8 :2010	Electromagnetic compatibility (EMC): Testing and measurement techniques - field immunity test frequency magnetic grid.
The device complies with Directive 2004/108/EC (EMC).	

	Meets the standards - SAFETY
EN 62040-1 :2008	Uninterruptible power systems (UPS): General and safety requirements for UPS.
EN 60950-1:2006	Equipment of teleinformation. Security.
IEC 60417	Symbols used on devices
The device complies with Directive 2006/95/EC (LVD).	

- Keep this user manual! It contains important information regarding the operations of UPS which should be used during installation and maintenance of the UPS and batteries.
- If the power supply is cold and will be moved to a warm room, condensation may occur. Therefore, you should wait at least 2 hours until its launch.
- To reduce the risk of electric shock, the UPS should be installed in a room free of contaminants at the right temperature and humidity. The ambient temperature must not exceed 40°C.
- Do not connect to the UPS output devices, which can cause it to overload, eg. Laser printers, electric heaters, etc..
- Cables should be connected and positioned in such a way that no one has the possibility of accidentally occur, or disconnected.
- The UPS must be connected to the wall socket with the proper protective conductor (PE).
- Do not block ventilation openings in the UPS. Make sure that the ventilation holes are discovered and there is a minimum of 25cm of free space for free ventilation.
- Power supply socket UPS should be protected by an appropriate switch or circuit breaker.
- The UPS has its own power source of the battery, so sockets output voltage may be present, although the UPS is not connected to the network.
- Support the battery should be performed by trained personnel who are knowledgeable about the battery life and retain appropriate precautions during their use.
- When replacing the batteries, use batteries of the same amount and with the same parameters, ie. Nominal voltage, capacity and dimensions.

WARNING! Do not dispose of batteries in a fire. The battery may explode.

WARNING! Do not open or damage batteries. Released electrolyte is harmful to skin and eyes. It may be toxic.

- A battery can present a risk of electric shock. When working with batteries, take the following precautions:
 - Remove from the hand of watches, rings and other metal objects.
 - Wear rubber gloves and boots.
 - Do not lay tools or metal parts on the battery.
 - Disconnect the source for charging the battery before connecting or disconnecting battery terminals.
- Make sure the battery is not accidentally grounded. If present, remove the source of ground fault. Contact with any part of a grounded battery can result in electrical shock.

2. Transport, unpacking UPS

Check carefully that the carton and the contents are not damaged. If any damage is found, immediately notify the shipping company and distributor of power supply. Do not dispose carton of UPS.

1. If there was not any damage carefully open the carton.
2. Extract all the protective elements (sponges, fillers).
3. Gently remove the UPS from the protective film and place it on a clean, flat, stable surface.

The UPS should be transported only in the original packaging to prevent damage to mechanical shocks and impacts.

2.1. Rack 19" Installation

UPS CORE series can be mounted in rack 19 ". UPS (2U) and battery module (3U) requires of space for installation. Each element requires optional mounting brackets (rack rails) for fixing the rack.

For proper installation of the following:

Step 1

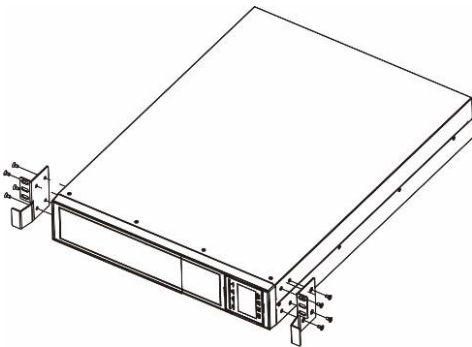

Step 2

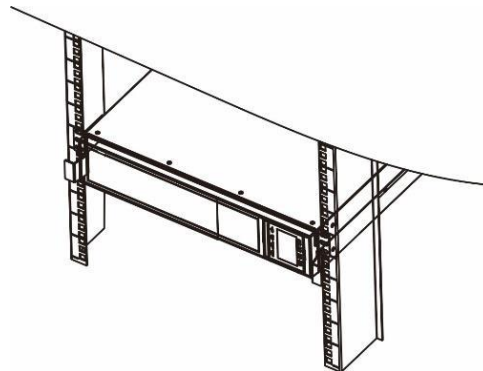

2.2. Tower Installation

To install the power supply in a Tower, use the special stands mounting adapter and allow its stable foundation in a vertical position.

For proper installation of the following:

Step 1

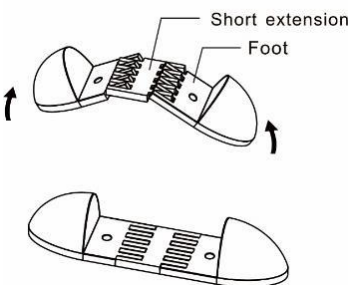

Step 2

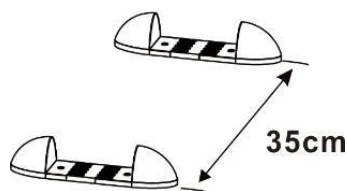

Step 3

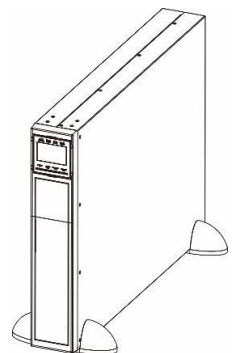

3. Design and connection

3.1. Rear panel view

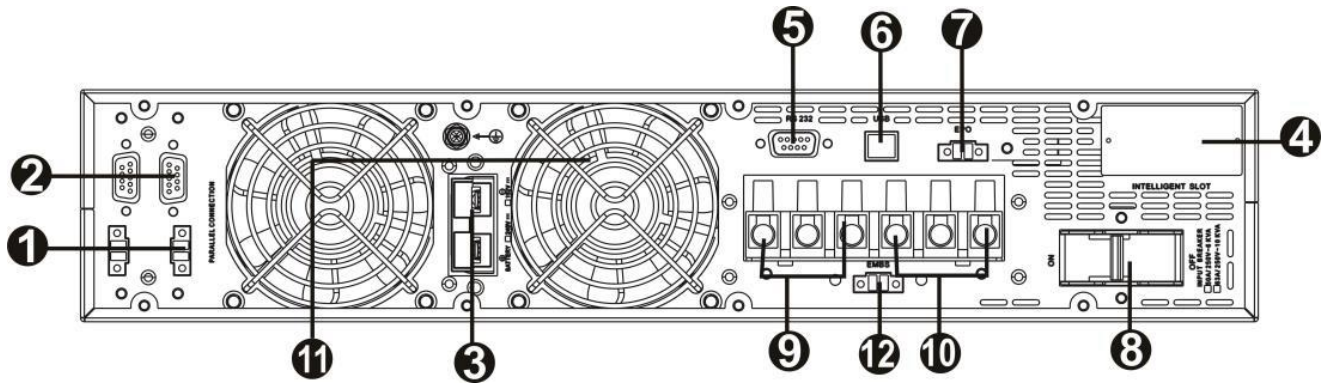

Draw 1 UPS COVER CORE 6-10K

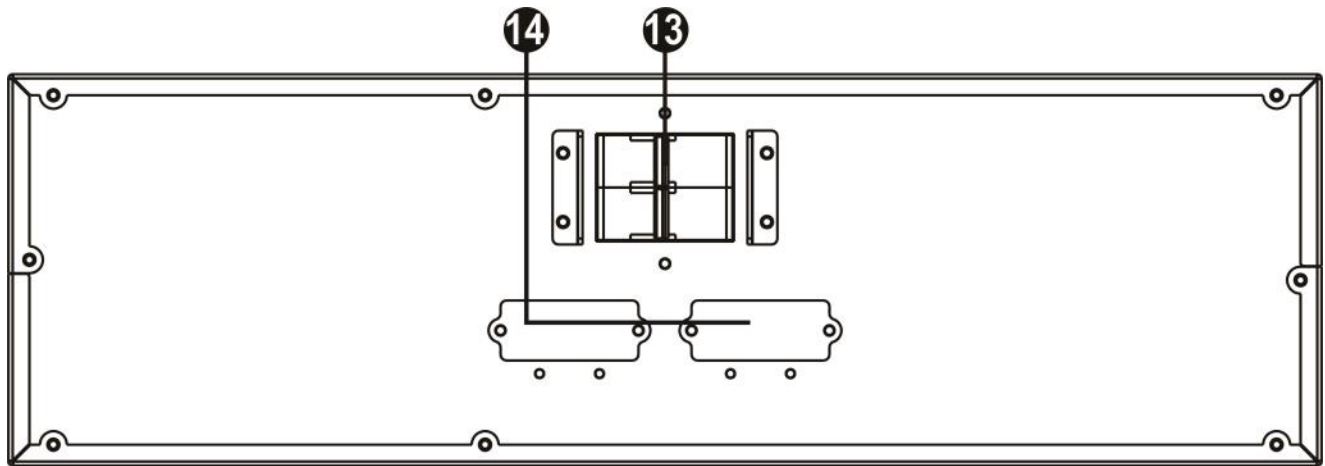

Draw 2 Battery module COVER CORE 6-10K

1. Current Connector (version only parallel operation)
2. Connector for parallel operation (only for versions of parallel operation)
3. External battery connector
4. Slot for SNMP
5. RS-232
6. USB
7. Remote EPO
8. Circuit breaker
9. Output terminal
10. Input terminal
11. Fans
12. Input controlling maintenance external bypass
13. Battery breaker
14. Additional battery connector.

*Make sure that between the UPS and the battery module is mounted battery breaker.
Before connecting the battery module and the breaker UPS must be OFF.*

3.2. Connection of external batteries

Connect one end of the battery into the corresponding slot on the rear panel of the UPS, the other end of the slot located on the battery unit. In the case of a larger number of modules the battery, the remaining connections are made between the battery modules provided as shown below.

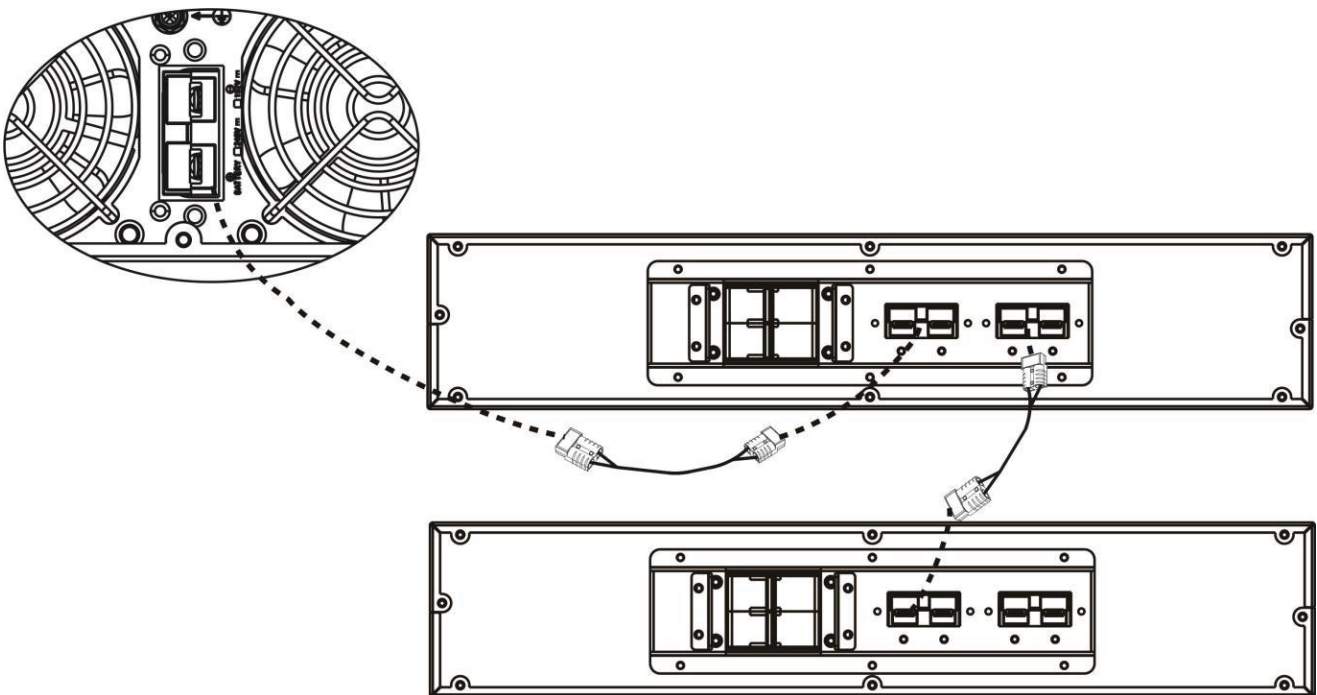

If you need to extend the autonomy, the power supply has the ability to connect batteries a much larger capacity, by fitting him with an adjustable Charger with capacity 4A. Setting the maximum charging current of the battery is made by authorized service of COVER UPSes.

In the case of the external battery of greater capacity, arranged for racks or cabinets, pay special attention to the installation of additional switch on a battery and the correct polarity of the wires connected from batteries to the UPS. Incorrect wiring "+" and "-" may cause permanent damage to the UPS.

3.3. Connection of input and output

UPS CORE 6K and 10K is designed for permanent connection via terminal which is localized on the rear side of UPS, as shown below.

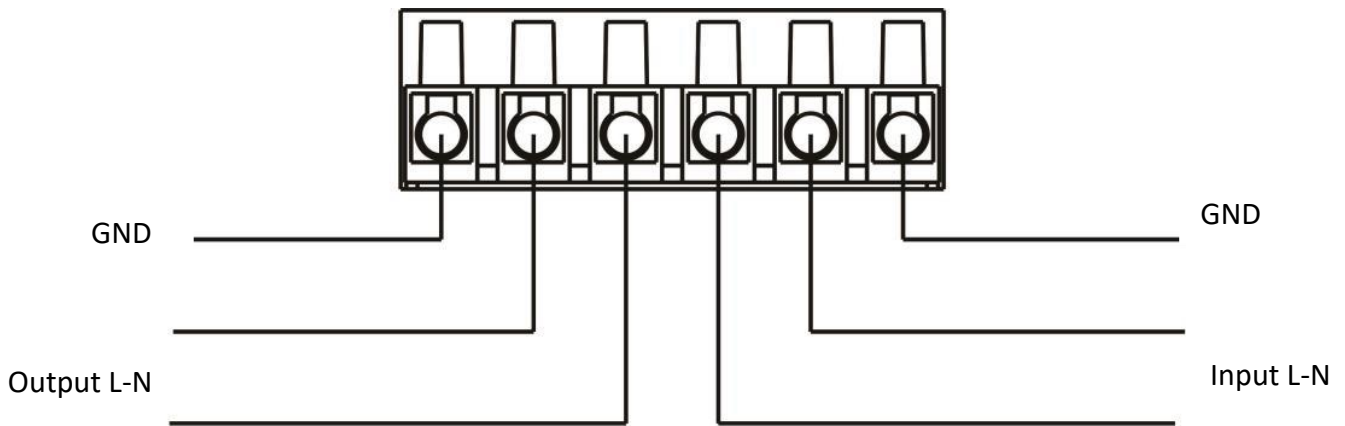

UPS suitable for installation in single-phase three-wire, TN with grounded neutral.

The UPS must be connected to a separate electrical system, made in accordance with the applicable in the national rules and regulations. Input circuit UPS should be protected switch over-current or fuse-element of the required recommendations in the current response. On the input side of the UPS is not recommended to use a residual current device.

The cables should be connected and arranged in such a way that no one have the possibility of their accidental disconnection.

3.4. Remote EPO connection

UPS has a EPO port for connecting the remote REPO switch (Remote Emergency Power Off). Normally EPO port is configured as a normally closed (NC), activation EPO takes place by interrupting the connection between Pin 1 and Pin 2 (removal jumper). You can change the configuration of EPO to NO (normally open) with level settings menu on the LCD. Changing the configuration to NO It makes it necessary to remove the jumper between pin 1 and pin 2.

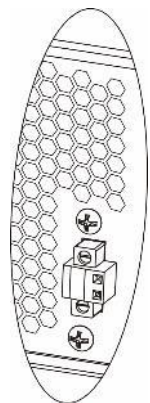

3.5. Communications connection

The UPS is equipped with three communication ports:

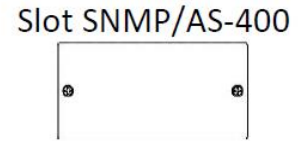

To enable automatic management and monitoring of the UPS, connect the supplied UPS USB cable from one side to the USB port on the UPS and the other into the USB port on your computer. Supplied with the UPS software allows you to automate processes on / off receivers connected to the power supply depending on the events that occur on the UPS (Eg. Power failure, low battery, overload, etc.).

The software allows also for current monitoring and recording the history of the event UPS. UPS also has a slot for an additional card, which allows retrofitting adapter SNMP for remote communication via the Internet or a card of the relay contacts AS-400 to communicate with external surveillance systems for example. BMS.

Warning! RS-232 and USB can not be used together.

4. Operations of LCD

4.1. Button operations

On the control panel of the UPS has 4 buttons for operating the UPS and LCD.

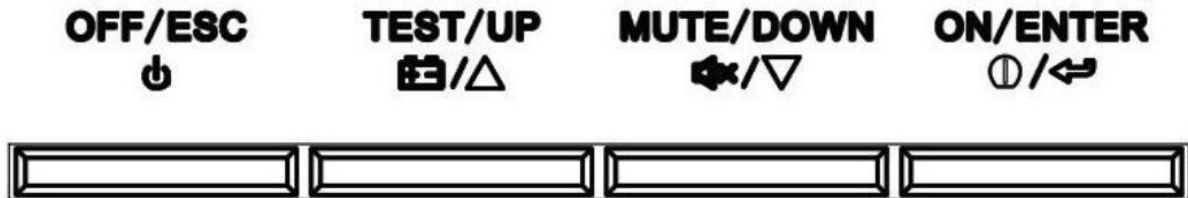

Button	Function
ON/ENTER	<ul style="list-style-type: none"> Turning on UPS: Press and hold for more than 0.5 seconds to turn on UPS. ENTER: Press to confirm a selection in the UPS.
OFF/ESC	<ul style="list-style-type: none"> Turning off the UPS: Press and hold for more than 0.5 seconds to shutdown UPS. ESC: Press to return to the previous menu page.
TEST/UP	<ul style="list-style-type: none"> Battery test: Press and hold for more than 0.5 seconds while normal operation of the UPS to activate the test. Up Arrow: Key scroll up to the previous line in the menu UPS settings.
MUTE/DOWN	<ul style="list-style-type: none"> Mute the alarm: When the UPS is on battery, press and hold less than 0.5 seconds to mute or enable signal sound. Mute alarm is not possible in the event of alarm. Down Arrow: key to scroll down to the next line in the menu UPS settings.
TEST/UP + MUTE/DOWN	<ul style="list-style-type: none"> Input or output to / from the menu: Press both keys simultaneously more than 1 second to enter or exit the setup menu UPS.

4.2 LED indicators

The UPS is equipped with an intuitive LCD panel and four LEDs for easy reading of the status of the UPS.

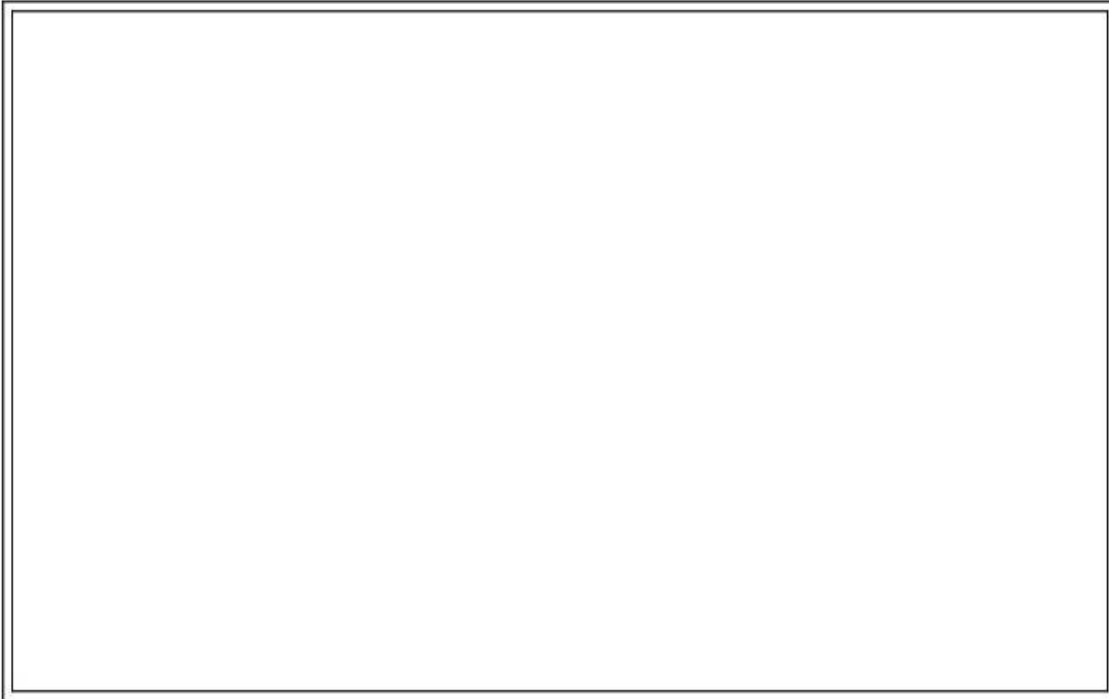



LED status determines the current status of the power supply and is described in the table below:

Mode \ LED	Bypass	Line	Battery	Fault
UPS Startup	●	●	●	●
No Output mode	○	○	○	○
Bypass mode	●	○	○	○
AC mode	○	●	○	○
Battery mode	○	○	●	○
CVCF mode	○	●	○	○
Battery Test	●	●	●	○
ECO mode	●	●	○	○
Fault	○	○	○	●

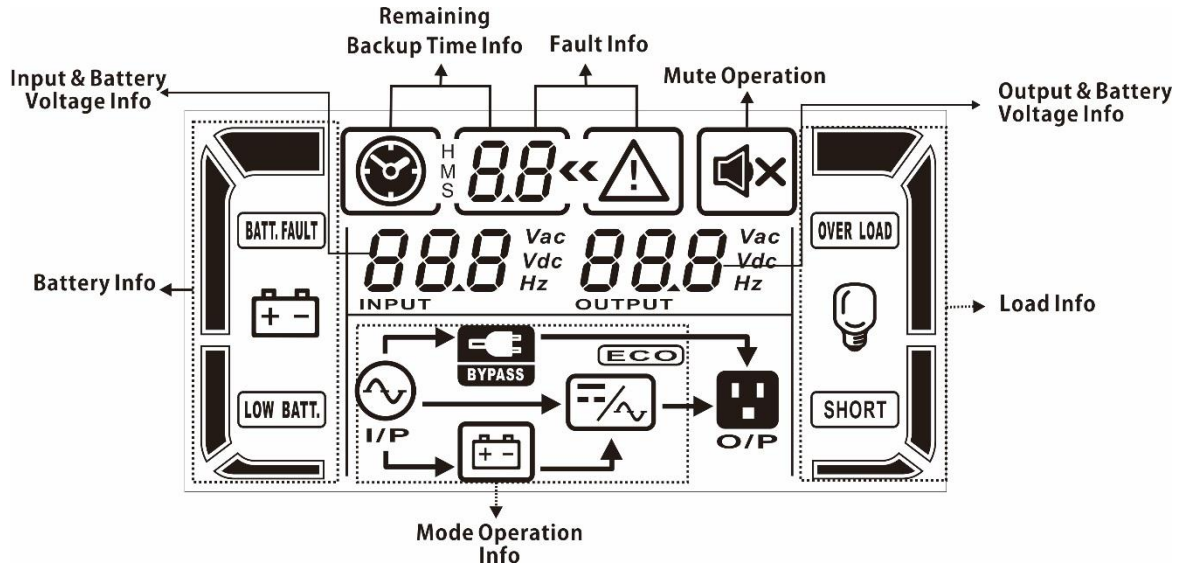
4.3 LCD Screen

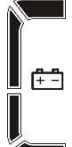

Screen	Function
Information about autonomy time	
	Displays the estimated time of autonomy of the power supply H: hours, M: minutes, S: seconds
Configuration and error messages	
	It informs about the appearance of an error or warning.
	It informs an error code or warning.
Output information	
	Displays the parameters of voltage or frequency output and the battery voltage. Vac: output voltage, Hz: output frequency, Vdc: battery voltage
Load information	
	Display the level of load: 0-24%, 25-49%, 50-74%, i 75-100%.
	Displays overload.
	Displays shortcut on the output of equipment.
Information about the operating mode	
	It indicates that the UPS is connected to a 230V.
	It indicates that the UPS is operating on battery power.
	It indicates that the UPS is in Bypass.
	It indicates that the ECO mode is enabled.
	It indicates that the UPS inverter is working.
	It indicates that the output voltage is present.
	It indicates that sound is muted.

Information about batteries	
	It indicates the level of charge 0-24%, 25-49%, 50-74%, i 75-100%.
BATT. FAULT	It indicates the status of damage to the battery.
LOW BATT.	It indicates the status of the low battery voltage.
Information about the parameters of power and battery voltage	
	Displays voltage and input frequency and voltage of the battery. Vac: Voltage network 230V, Vdc: Battery voltage , Hz: frequency network

4.4 Signal alarms

Battery mode	Sounding every 5 seconds.
Bypass mode	Sounding every 2 minutes.
Overload	Sounding 2x second.
Fault	Sounding constant.

4.5 Letter abbreviations LCD

Short	The display	Meaning
ENA	ENA	Enabled
DIS	di S	Disabled
ATO	AtO	Auto
BAT	bAt	Battery
NCF	nCF	Normal mode
CF	CF	Converter mode
SUB	SuB	Subtract
ADD	AdD	Add
ON	ON	Turn on
OFF	OFF	Turn off
FBD	Fbd	Forbidden
OPN	OPn	Allow
RES	rES	Reserved
OP.V	OPV	Output voltage
PAR	PAR	Parallel

4.6 Settings

To access the configuration menu, simultaneously press for more than 1 second keys Test / MUTE + Up / Down. View the configuration menu and description of possible settings below. To get access to all UPS settings should be in stand-by mode (no output voltage UPS) or Bypass.

Parameter 1





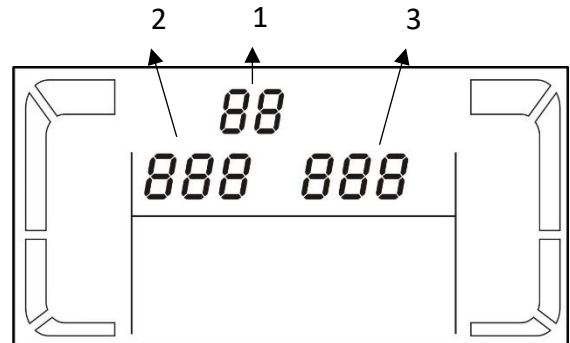

Indicates the number assigned to a particular parameter as described below, eg. 01 - output voltage.





Parameter 2 and 3

It indicates a specific value for a given parameter, eg. 230 - output voltage.

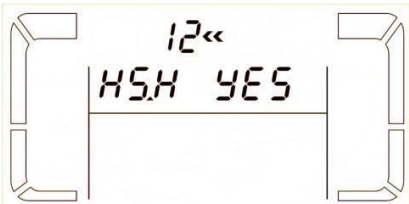

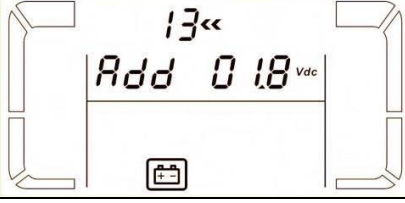
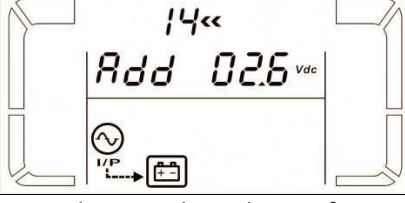

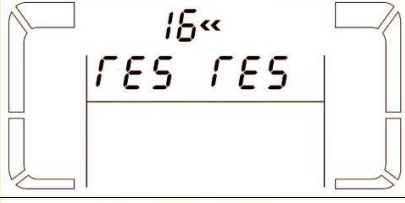

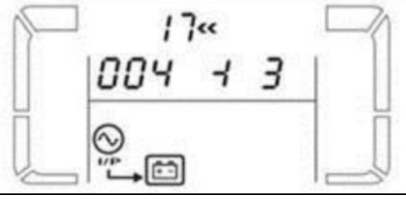
Display status	Settings
01 - Setting the output voltage	
	<p>208: It indicates the output voltage 208Vac 220: It indicates the output voltage 220Vac 230: It indicates the output voltage 230Vac (default) 240: It indicates the output voltage 240Vac</p>
02 – Output frequency	
<p>60 Hz, CVCF mode</p>	<p>Parameter 2: Output frequency Allows you to select the frequency: 50Hz Output frequency 50 Hz 60Hz Output frequency 60 Hz ATO: autosensing. UPS automatically detects the frequency of the supply voltage.</p> <p>Parameter 3: CF: UPS operates as a frequency converter. The output frequency should be set to 50 or 60 Hz. NCF: UPS is in normal mode, the tolerance limits the input frequency UPS synchronizes to the AC frequency. Exceeding the permissible frequency tolerance makes the transition to the UPS battery operation.</p> <p>Warning! During CF - frequency converter bypass function is automatically locked.</p>
<p>50 Hz, normal mode</p>	
<p>ATO</p>	
03 - Voltage range for bypass	
	<p>Parameter 2: Lower voltage range for Bypass. The value possible to set the 110-209V (110V default). Parameter 3: Higher voltage range for Bypass. The value possible to set the 231-276V (264V default).</p>

04 – Frequency tolerance range for Bypass	
	<p>Parameter 2: Lower voltage range for Bypass. 50Hz: 46-49Hz possible settings (default 46Hz) 60Hz: 56-59Hz possible settings (default 56Hz)</p> <p>Parameter 3: higher voltage range for Bypass 50Hz: 51-54Hz possible settings (default 54Hz) 60Hz: 61-64Hz possible settings (default 64Hz)</p>
05 – ECO mode	
	<p>Setting the availability of economy mode ENA: ECO function available DIS: ECO function not available (default)</p>
06 – Voltage range in ECO mode	
	<p>Parameter 2: Setting the lower tolerance voltage ECO mode. Possible settings -5% to -10% of nominal input voltage.</p> <p>Parameter 3: Setting the upper tolerance voltage ECO mode. Possible settings +5% to +10% of the nominal input voltage.</p>
07 – Frequency tolerance range in ECO mode	
	<p>Parameter 2: Setting the lower frequency tolerance for ECO mode. Possible settings: 50Hz: 46Hz ÷ 48Hz (default 48Hz) 60Hz: 56Hz ÷ 58Hz (default 58Hz)</p> <p>Parameter 3: Setting the upper frequency tolerance for ECO mode. Possible settings: 50Hz: 52Hz ÷ 54Hz (default 52Hz) 60Hz: 62Hz ÷ 64Hz (default 62Hz)</p>
08 – Settings of Bypass mode	
	<p>Parameter 2: OPN: Bypass allowed. UPS can operate in Bypass depending the setting of available / unavailable. FBD: Bypass not allowed in any situation.</p> <p>Parameter 3: ENA: Bypass available. DIS: Bypass available - indicates lack of work force Bypass manually from the front panel LCD. Bypass automatic available.</p>
09 – Reducing runtime battery operation	
	<p>Parameter 2: Set the maximum working time of the battery 0 - 999 minutes for a critical slots (not programmable). DIS: Lock restrictions. Autonomy depends on the capacity of the battery.(Default) Warning! A setting of "0" - means the autonomy of 10 seconds.</p>
10,11– Reserve (No features available)	
12 - Availability features Hot Standby	
	<p>You can enable or disable the Hot Standby HS.H YES: Function available. It allows you to restart the UPS after a power supply even without a connected battery. NO: function disabled. UPS is operating normally and will not turn on without a connected battery.</p>

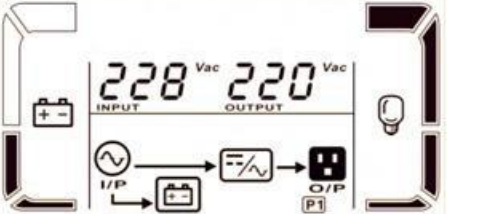
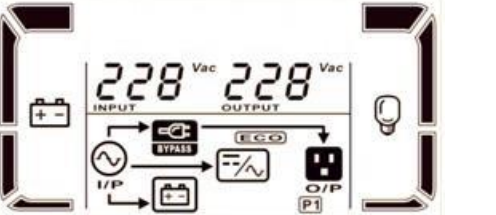
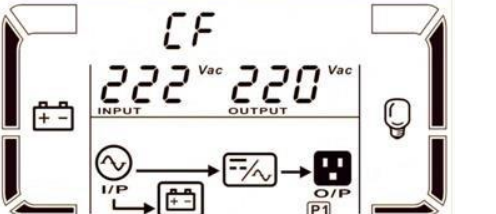
13 - Adjusting the voltage of the battery	
	<p>Parameter 2: Select "Add" or "Sub" to adjust the up / down voltage battery.</p> <p>Parameter 3: Voltage adjustment range 0 - 5,7V (by default 0V).</p>
14 - Voltage regulation of Charger	
	<p>Parameter 2: Select "Add" or "Sub" to adjust the up / down voltage of Charger.</p> <p>Parameter 3: Voltage adjustment range 0 - 9,9V (by default 0V). Prior to the calibration of the batteries must be disconnected.</p>
15 - Adjusting the voltage of inverter	
	<p>Parameter 2: Select "Add" or "Sub" to adjust the up / down voltage of Inverter.</p> <p>Parameter 3: voltage regulation 0 - 6,4V (by default 0V).</p>
16 – Output voltage regulation	
	<p>If the output voltage can not be identified (less than 50V) in the menu is not possible to make changes.</p>
	<p>Parameter 2: indicates the output voltage OP.V</p> <p>Parameter 3: Indicates the UPS output voltage measured inside the UPS. Using the arrow keys to calibrate the output voltage to the actual value indicated by the meter. The calibration result is obtained confirming change by Enter button. Voltage adjustment range +/- 9V.</p>
17- Adjusting the battery charging current	
	<p>Parameter 2: Allows you to adjust the charger's current. Parameter accepts values 1/2/3 or 4A.</p> <p>Parameter 3: Allows you to calibrate the charger current by a value of ± 0.5 A.</p>

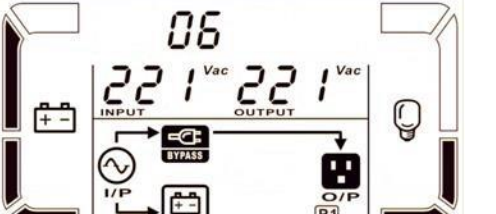
4.7 Description of UPS modes

Working mode	Description	Screen status
Online mode	If the voltage is within the tolerance limits, the UPS supplies applications directly from the network. In this mode, after the battery is fully charged the fans are turned off in order to improve the efficiency of operation	
Eco mode	Eco mode If the supply voltage is within the tolerance limits, the supply voltage is supplied directly to the output of the UPS. The inverter is in stand-by mode, which increases the efficiency and reduce operating costs.	
CVCF mode	If the frequency of the supply voltage is within the 46 ÷ 64Hz, there the ability to set a fixed value output frequency of 50 or 60Hz. In this mode, the batteries are charged.	
Battery mode	In the event of a power failure or when the supply voltage is beyond the tolerance allowing the output voltage to be kept within the required tolerance, the UPS switches to battery operation. The beep sounds every 4 seconds.	
Bypass mode	If the supply voltage is within acceptable tolerance limits, but there is overload or any other event that UPS will switch to Bypass. A beep is issued every 2 minutes.	
Battery test	Press half a second key "Test" in the course, when the UPS is operating in normal or frequency converter will force a battery test.	
Alarm	In safe mode, the UPS indicates an error code, and icons allocated for the event.	

4.8 Warning codes

Warning code	Warning event	Warning code	Warning event
01	Battery unconnected	10	L1 IP fuse broken
07	Over charge	21	Line situations are different in paralel system
08	Low battery	22	Bypass situations are different in paralel system
09	Overload	33	Locked in bypass after overload 3 times in 30 min
0A	Fan failure	3A	Cover of maintain switch is open
0B	EPO enable	3D	Bypass unstable
0D	Over temperature	3E	Boot loader is missing
0E	Charger failure		

4.9 Error codes

Error	Code	Icon	Error	Code	Icon
Error starting BUS	01	X	Tyristor battery shorted	21	X
High voltage BUS	02	X	Relay inverter shorted	24	X
Low voltage BUS	03	X	Shortcircuit in the charger	2a	X
Uneven voltage on rails BUS	04	X	Error of CAN communication	31	X
Error starting inverter	11	X	Uneven load at the output of the parallel operation	36	X
High inverter voltage	12	X	High temperature	41	X
Low inverter voltage	13	X	Error of CPU communication	42	X
Short circuit on inverter output	14		Overload	43	X
Power supply fault	1A	X	Error of cold start	6A	X
Inverter Overload	60	X	PCF damage	6B	X
Abnormal shape inverter voltage	63	X	Waving voltage BUS	6C	X

4.10 Warnings UPS and audible alarms

Warning	Icon	Alarm
Low voltage battery		Sounding every 1 second
Overload		Sounding every 1 second
Batteries disconnected		Sounding every 1 second
Overcharged		Sounding every 1 second
Damage of fuse		Sounding every 1 second
EPO active		Sounding every 1 second
Overheat / Fan Fault		Sounding every 1 second
Charger fault		Sounding every 1 second
Overload 3 times in last 30 minutes		Sounding every 1 second

4 Operation of UPS

5.1 Turn on UPS

1. Close a battery breaker located on the rear panel of the battery module or near the battery cabinet if the external battery is existed.
2. Close supply UPS in switchgear. At the moment it is powered on, the LCD panel lights up and the fans are starting to work. A few seconds later, the UPS activates Bypass mode.

Power on the UPS means active Bypass mode. The loads are power from the main voltage and are not protected from power outages.

To start the UPS inverter turn on the UPS – step 3.

-
3. To turn on the power supply, press and hold for more than 0.5 seconds ON button on the display UPS. UPS will confirm the start with beep.
 4. A few seconds later, the UPS turns on the inverter and starts in normal mode.

In the case where the supply voltage is out of tolerance UPS battery starts to work. After discharging the battery power is turned off. Return power causes Auto restart the UPS to normal operation.

Warning! In order to obtain the maximum length of autonomy to charge the batteries at least 10h after the first run. The maximum capacity of the battery is reached after two full cycles of discharging / charging.

5.2 Turn off UPS

1. Turn off the UPS inverter by pressing the OFF button for more than 0.5 seconds. UPS confirms the exclusion of single beep and switch to Bypass.

If the UPS operates on battery above procedure turns off the UPS and the output voltage.

-
2. In Bypass mode, the voltage at the output is supplied directly from the network. To completely shut down the UPS, turn off the devices connected to the UPS then remove power to the UPS. A few seconds later, the UPS switches off the LCD panel and stops the fans.
 3. Switch the battery circuit breaker to the OFF position.

5.3 Turn on UPS from batteries

1. Close a battery breaker located on the rear panel of the battery module or near the battery cabinet if the external battery is existed.
2. Press ON to turn the UPS to Stand-by. After switching on the display, press the ON key again for more than 0.5 seconds to turn the inverter and give the voltage at the output of the UPS.
3. A few seconds later, the UPS goes into battery mode.

5.4 Switch UPS to Bypass Service mode

The following procedure applies to UPS equipped with an external Maintenance Bypass. Turn UPS to Bypass mode service means that consumers are not protected from power outages.

1. Turn off the UPS inverter by pressing the OFF button for more than 0.5 seconds. UPS confirms the exclusion of single beep and switch to Bypass.
2. Switch External Bypass Switch from UPS to BYPASS position.
3. To completely shut down the UPS, turn off the power supply UPS. A few seconds later, the UPS switches off the LCD panel and stops the fans.
4. Switch the battery circuit breaker to the OFF position.

5.5 Switch UPS from bypass service mode to normal mode

1. Close a battery breaker located on the rear panel of the battery module or near the battery cabinet if the external battery is existed.
 2. Close supply UPS in switchgear. At the moment it is powered on, the LCD panel lights up and the fans are starting to work. A few seconds later, the UPS activates Bypass mode.
-

Make sure that the Bypass LED lights to go to the next step.

3. Switch External Bypass Switch from BYPASS to UPS position.
4. To turn on the power supply (inverter start), press and hold for more than 0.5 seconds ON button on the display UPS. UPS will confirm the start with beep.
5. A few seconds later, the UPS turns on the inverter and starts in normal mode.

5.6 Battery test

To activate the power supply function test, while the UPS is in normal mode, economic or as a converter press TEST. UPS automatically performs a test, and then pass automatically to the previous status.

The battery test can be performed periodically in automatic mode after proper configuration.

5.7 Mute audible alarm

During the UPS battery are issued beeper. To silence the UPS, press and hold for more than 0.5 seconds press MUTE

5.8 Software installation

To take full advantage of the UPS Install the software communication ViewPower.

During installation, follow the instructions that appear on the computer screen. After the installation process is complete, restart the computer. Restarting the computer will automatically start ViewPower, which is shown ViewPower icon appears in the Windows system tray.

6 Operating environment and operation of the UPS

6.1 Operating conditions

To ensure proper working conditions for UPS system, the room in which the power supply must be clean and free of dust and dirt. From time to time (not less frequently than every 6 months or more frequently depending on the degree of dirt), clean the air vents on the power supply, to ensure the free flow of air.

To extend the life of the battery, the ambient temperature should be between 15-25 ° C.

6.2 Storage conditions

If the UPS is not used and it is expected to, from time to time required to charge the battery in order to avoid their destruction. Depending on the storage temperature should be at least every six months to connect the AC adapter to charge the battery. Typically, the batteries are charged during 4 hours to 90% capacity, but it is advisable to leave the included power supply for a period of 24-48 hours to fully charge the battery, thus extending their life.

Temp. for up to 20 ° C - charging every six months.

Temp. for up to 30 ° C - charging every three months.

Temp. for up to 40 ° C - charging every one month.

6.3 Battery replacement

If the back time of the UPS is reduced by half compared to the nominal efficient batteries or when the UPS report an alarm batteries, the batteries must be replaced immediately.

After disconnecting the battery, consumers are not protected from power outages.

We do not recommend replacing the battery while the UPS is working and the load is connected.

Do not replace the batteries while the UPS is in battery mode!
